

K-METRON (FW 3.0.7)

493K THICKNESS MEASUREMENT GAUGE (0-30mm)

WITH RADIO LINK UP AND SOFTWARE RECORDING



USER INSTRUCTIONS (Doc v4.0.0) RELATING TO FIRMWARE VERSION (FW 3.0.7)

(as displayed on boot-up of the K-METRON)

IMPORTANT

Read all instructions before use

Observe safety precautions



493K Limited
23 Watch Hill Road
Ballyclare, BT39 9QW
United Kingdom
T: +44(0)28 93359922
E: solutions@493k.com

1 CONTENTS

2	GENERAL OPERATION	3
2.1	Turning the unit ON & OFF.	3
2.2	Entering the Configuration Menu.	3
2.3	The Measurement End of the Sensor Head	4
2.4	Coupling the Sensor Head with the Calibrated Magnet.....	4
2.5	Loss of Magnetic Coupling.	5
2.6	Tracking the Sensor Head to the Point of Measurement.....	5
2.7	Inserting the Sensor Head in the Dock.....	5
2.8	Visual Display Terminology.....	5
3	MEASURING DIFFERENT MATERIALS	6
3.1	Materials that can be measured.....	6
3.2	Materials that Cannot be Measured.....	6
3.3	Measuring Non-ferrous Metal Parts.	6
4	CALIBRATING THE K-METRON.....	7
4.1	Entering the Calibration Menu.	7
4.2	Calibrating the K-METRON.....	8
4.3	Validating Calibration.	10
5	CHOOSING THE CORRECT MAGNET	11
5.1	Selecting the Magnet Type.	12
6	POSITIONING OF THE SENSOR HEAD	13
6.1	Correct Sensor Head Position & Orientation.	13
6.2	Measuring an External Radius with K-METRON.....	14
6.3	Measuring an Internal Radius with K-METRON.	14
6.4	Sensor Head Care	14
6.5	The Sensor Head Dimensions.	15
7	TAKING A THICKNESS MEASUREMENT.....	16
7.1	Out of Measurable Range Thicknesses.	16
7.2	Deleting a Thickness Measurement.....	17
7.3	Indexing Mould ID.	17
7.4	Units of Measurement.....	17
8	using the K-METRON's pc SOFTWARE.....	19

8.1	Connecting the K-METRON to the PC & Installing the Communications Driver.	19
8.2	Downloading the K-METRON Software.....	19
8.3	Setting the Correct Communications Port.	19
8.4	Start Recording.....	20
8.5	Activating and De-activating the Radio Communication.....	21
8.6	Recording the Thickness Measurements.	21
8.7	Continuous Internal Database Recording	22
8.8	Exporting to Excel	23
8.9	Erasing Unwanted Data.	24
9	K-METRON BATTERY POWER	25
9.1	Battery Type	25
9.2	Replacing the Battery in K-METRON	25
9.3	Battery Life	25
10	K-METRON - WHAT'S INCLUDED	26
11	TECHNICAL SPECIFICATIONS.....	27
12	DISCLAIMER.....	27
13	DECLARATION OF CONFORMITY	28

2 GENERAL OPERATION

2.1 Turning the unit ON & OFF.

To turn the unit ON momentarily press the ON/OFF switch on the face of the K-METRON until the Display illuminates. Battery level will be checked each time the unit is turned on, and if a low battery voltage is detected then a warning will be displayed on start up.

To turn the unit OFF, momentarily press the ON/OFF switch on the face of the K-METRON until Display goes off.

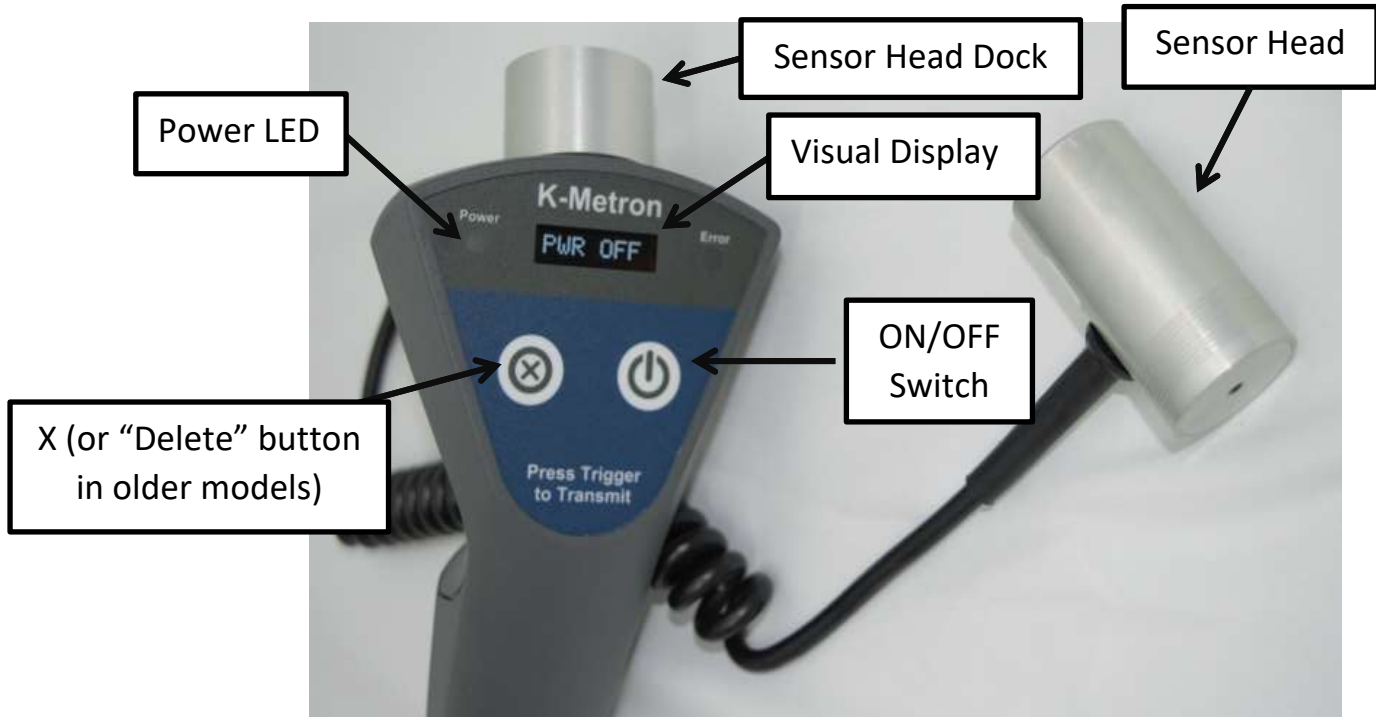

The unit will auto power off after 3 minutes of inactivity. A warning “PWR OFF” is displayed after 1 minute of inactivity. The unit can be interrupted from auto power off by pressing either the orange trigger or the X (or “Delete”) button; pressing either will only interrupt the auto power off and will neither ‘transmit’ nor ‘delete’ any data.

2.2 Entering the Configuration Menu.

To enter the configuration menu, where Magnet Type, Calibrate, Units, and Radio Menus are stored, use the following button presses starting from when the K-METRON is in the OFF state:

1. Hold down the X button (or “Delete” button in older models) and switch the unit on by pressing the On/Off button.
2. Continue to hold down the X (or “Delete”) button, the display will read “Wait ... Setup mode”.
3. Continue holding down until the display reads “MAG TYPE” then release the X (or “Delete”) button. (Ensure that the orange trigger is not being mistakenly held down).
4. Once the display reads “MAG TYPE”, the unit is now in the Configuration Menu.

The Configuration Menu is navigated using the following buttons:

To SCROLL through the Menus, press X (or “Delete”).

To SELECT a Menu item, press the ORANGE TRIGGER.

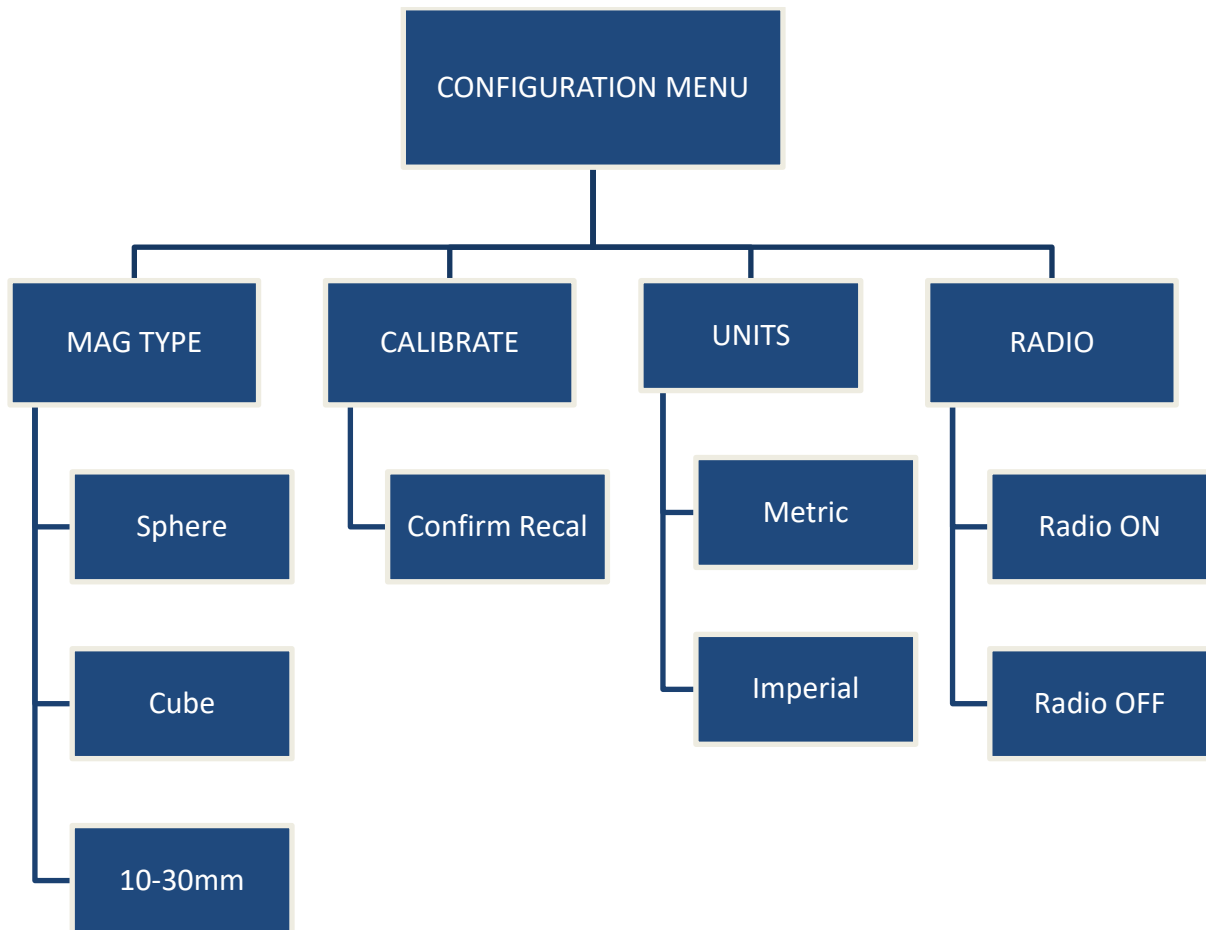

2.3 The Measurement End of the Sensor Head

The measurement end of the sensor will attract the magnet. Ensure this end of the sensor is in contact with the surface of the part to be measured.

2.4 Coupling the Sensor Head with the Calibrated Magnet.

Place the Sensor Head on one face of the product that is to be measured. Hold or place the magnet on the opposite side of the product wall until it couples to the sensor head.

Hollow objects can be measured by inserting the calibrated magnet through a small opening in the product. The magnet should immediately be coupled with the sensor head positioned on the outside of the product and adjacent to the aperture. The sensor head can then be slid over the surface of the product to the desired place of measurement. Movement should be slow and steady. Care should be taken when moving the sensor head to avoid de-coupling.

2.5 Loss of Magnetic Coupling.

When magnetic couple of the cube magnet is lost it can be retrieved by retaining the end of the attached cord and fishing the magnet out of the opening. If the spherical magnet loses coupling, then it must be retrieved by turning the moulding upside down and allowing the magnet to fall out or by using a telescopic metal pointer to grab it.

2.6 Tracking the Sensor Head to the Point of Measurement.

The calibrated magnet will automatically couple, orientate and centre itself over the Sensor Head. Once coupled track the Sensor Head to the point on the part which you wish to measure, taking care not to remove the sensor head from the face of the work piece. This may result in the loss of the magnetic coupling. The calibrated magnet will follow the Sensor Head to the desired point of measurement.

2.7 Inserting the Sensor Head in the Dock.

If the sensor head is difficult to engage in the Sensor Head Dock, then a thin film of grease should be applied to the O-ring found within the Sensor Head Dock.

2.8 Visual Display Terminology



Displayed Text	Meaning
N/M	No Magnet in range
O/R	Out of Range
Mag type: Cube	Selected Magnet: 10mm Cube
Mag type: Sphere	Selected Magnet: 10mm Sphere
Mag type: 10-30mm	Selected Magnet: 19mm Sphere
PWR OFF	In automatic Power Off Mode

3 MEASURING DIFFERENT MATERIALS

The unit does not require re-calibration for use with different materials. This equipment will measure materials of a thickness between 2mm to 20mm where access can be achieved to both sides of the product being measured.

3.1 Materials that can be measured.

Non-ferrous materials of any density will return an accurate reading within the limits of the device. Materials that can be measured include all non-ferrous materials such as:

- *Plastics of any density or composition*
- *Foamed materials*
- *Laminates*
- *Fibreglass*
- *Carbon Composites*
- *Glass*
- *Aluminium*
- *Brass and copper*

The K-METRON allows the roto moulder to measure the full thickness of MULTI-LAYER mouldings.



3.2 Materials that Cannot be Measured.

The unit **cannot** be used to measure any kind of **ferrous materials**, e.g. steels & irons. The magnetic attraction found in these materials will affect the accuracy of the reading.

3.3 Measuring Non-ferrous Metal Parts.

When measuring the thickness of non-ferrous metal parts (e.g. aluminium or copper) ensure that there is **no movement** of the magnet during the measurement. ***The figure of 8 movement for these materials should be made to centre the magnet to the sensor head but should be stopped once centred and before the measurement is taken.***

4 CALIBRATING THE K-METRON

The unit may come with calibrated data already recorded for each of the magnets held in the unit's memory; this will be confirmed if a Calibration Certificate has been sent with the unit. The calibrated data associated with each type of magnet will be automatically called on selection of the magnet from within the configuration menu. After the K-METRON is calibrated with each type of magnet the values are stored within the K-METRON memory. Therefore, re-calibration is not necessary when switching between magnets; instead, the desired magnet is chosen in the configuration menu under the MAG TYPE section.

The K-METRON's accuracy improves with careful magnetic coupling between the sensor head and the part face. Measurement accuracy ranges from +/- 0.2mm at the lower end of the readings and +/- 1mm at the upper end of measurement. This will depend on whether the spherical magnet or the cube is used.

Although the units are calibrated before leaving 493K re-calibration may be necessary within your plant. This can be determined by selecting the appropriate magnet and validating the data as described below in section 4.3 Validating Calibration.

Select a location that is at least 1 metre away from any steel or ironwork which will affect accuracy of calibration.

Re-calibration is not required for use with differing materials.

4.1 Entering the Calibration Menu.

The Calibrate Menu is found within the configuration menu. Use the following button presses, starting from when the K-METRON is in the OFF state, to enter the Configuration menu:

1. Hold down the X button (or "Delete" button in older models) and switch the unit on by pressing the On/Off button.
2. Continue to hold down the X (or "Delete") button, the display will read "Wait ... Setup mode".
3. Continue holding down until the display reads "MAG TYPE" then release the X (or "Delete") button. (Ensure that the orange trigger is not being mistakenly held down).
4. Once the display reads "MAG TYPE", the unit is now in the Configuration Menu.

The Configuration Menu is navigated using the following buttons:

To SCROLL through the Menus press X (or "Delete").

To SELECT a Menu item, press the ORANGE TRIGGER.

Scroll through the menu using the X (or "Delete") button and select "Calibrate" by pulling the orange trigger. The unit will prompt for re-confirmation, and this is acknowledged again by pulling the orange trigger.

4.2 Calibrating the K-METRON.

Once in the Calibrate Menu the display should now read NM – no magnet. With no magnet near the sensor head, the trigger should be depressed and released.

After successfully acknowledging ‘NM – no magnet’ the unit will then request the 20mm position (+10mm disk for 10-30mm magnet). The magnet should be placed on the 20mm(+10mm disk for 10-30mm magnet) step and the trigger pulled. Confirmation of step calibration will be provided and then the next step thickness requested, i.e. 19mm. Slide the magnet onto the next step ensuring that it does not snap onto the next step to avoid damaging both the magnet and calibration step tool. The next position will be requested, i.e.18mm, and so on.

The magnet should be placed on each step so that it is in the centre of the step and is not interfering with the step edge. The sensor head should be centred on the magnet. Ensure that the magnet is not moving when calibrating as this will affect the calibration values.

The more accurately you can teach the K-METRON the thickness that it is measuring during calibration, the greater the accuracy of the part thickness measurement in the field.

Continue this step-by-step calibration down to the ‘Zero’ thickness with the magnet directly on the sensor surface.

If you make a mistake during the calibration sequence, press the X (or “Delete”) button to go back to the previous position.

For use of 19mm Spherical Magnet to use for the 10mm-30mm measurement range: Please note that a 10mm aluminium Disk is provided.



The disk features a groove for the sensor head to easily slide into, allowing the operator to calibrate +10mm in conjunction with the provided calibration step profile.

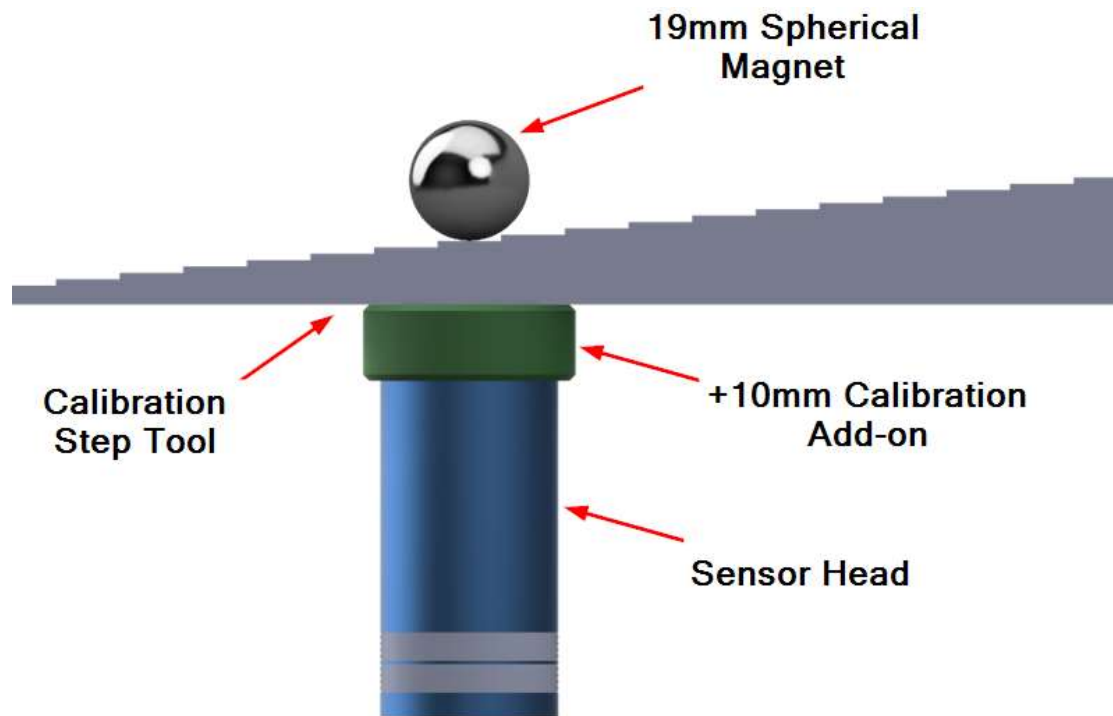

THE CUBE AND SPHERICAL MAGNETS ARE NOT INTERCHANGEABLE AND DOING SO WILL RESULT IN INACCURATE READINGS. THE MAGNET TYPE MUST BE SET IN THE CONFIGURATION MENU BEFORE USING THE K-METRON. IT IS ADVISABLE TO STORE ANY UNUSED MAGNETS IN THE K-METRON CASE TO AVOID MISTAKENLY LOSING OR USING THE WRONG MAGNET.

4.3 Validating Calibration.

After calibration is complete the measured data should be validated. To do this position the calibrated magnet once more on each step and ensure the K-METRON's measured and displayed value is that of the actual step thickness (note the measurement tolerances as per the table above apply).

Magnet Used	Mag Type	Calibration Range
10mm Sphere	Sphere	0mm - 20mm
10mm Cube	Cube	0mm - 20mm
19mm Sphere	10-30mm	10mm – 30mm

10mm Cube and 10mm Sphere Validating Calibration



19mm Sphere Validating Calibration – use the provided +10mm disk to measure units over 20mm.

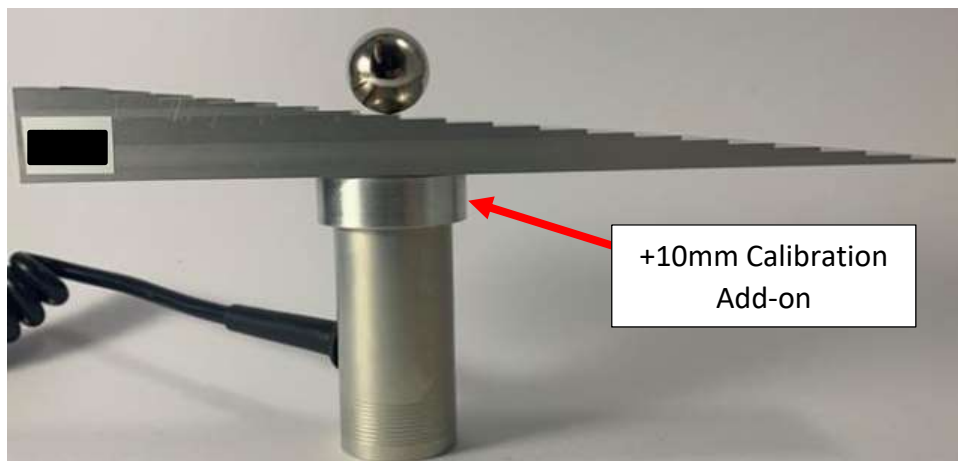

5 CHOOSING THE CORRECT MAGNET

The unit comes with three different types of magnets, a cube, a 10mm sphere, and a 19mm sphere. The desired range of measurement will be the major factor which will determine whether to use the cube or spherical magnet. The 10mm x 10mm x 10mm cube magnet is best for thick-walled parts (> 4mm). Since thick-walled parts are usually large a cord is supplied to help retrieve the magnet should it become de-coupled from the sensor head.



The 10mm spherical magnet is best for thinner parts when tight radii are to be measured. The measurement specifications for each of the magnets are shown in the Table below.

MEASUREMENT SPECIFICATIONS FOR CUBE AND SPHERICAL MAGNETS

METRIC	Part thickness	Accuracy	
10mm cube magnet	4mm – 20mm	4mm-17mm: +/- 0.2mm of reading 17mm +: +/- 1.0mm of reading	Factory Set
10mm sphere magnet	2mm-20mm	2mm-13mm: +/- 0.2mm of reading 13mm: +/- 1.0mm of reading	
19mm sphere magnet	10mm -30mm	10mm – 20mm: +/- 0.2mm of reading 21mm: +/- 1.0mm of reading	

IMPERIAL	Part thickness	Accuracy	
0.39" cube magnet	0.157" – 0.787"	0.157" – 0.669": +/- 0.008" of reading 0.669": +/- 0.039" of reading	Factory Set
0.39" sphere magnet	0.079" – 0.787"	0.079" – 0.512": +/- 0.008" of reading 0.512": +/- 0.039" of reading	
0.75" sphere magnet	0.39" – 1.1811"	0.39" – 0.787": +/- 0.008" of reading 0.787": +/- 0.039" of reading	

5.1 Selecting the Magnet Type.

To select the type of magnet to measure with, enter the Configuration Menu (Chapter 2.2) and select “MAG TYPE”; then scroll through until the desired Magnet type and select using the Orange Trigger. There are three types of Magnets to choose from:

Type of Magnet	Measurement Range
• Sphere	0mm - 20mm
• Cube	0mm - 20mm
• 10-30mm	10mm – 30mm

The data for each of the magnets is calibrated via the “Calibrate” menu.

Magnet selection map, press X(“Delete” for older version) button to cycle between the three magnet types:

To SCROLL through the Menus, press X (or “Delete”).

To SELECT a Menu item, press the ORANGE TRIGGER.

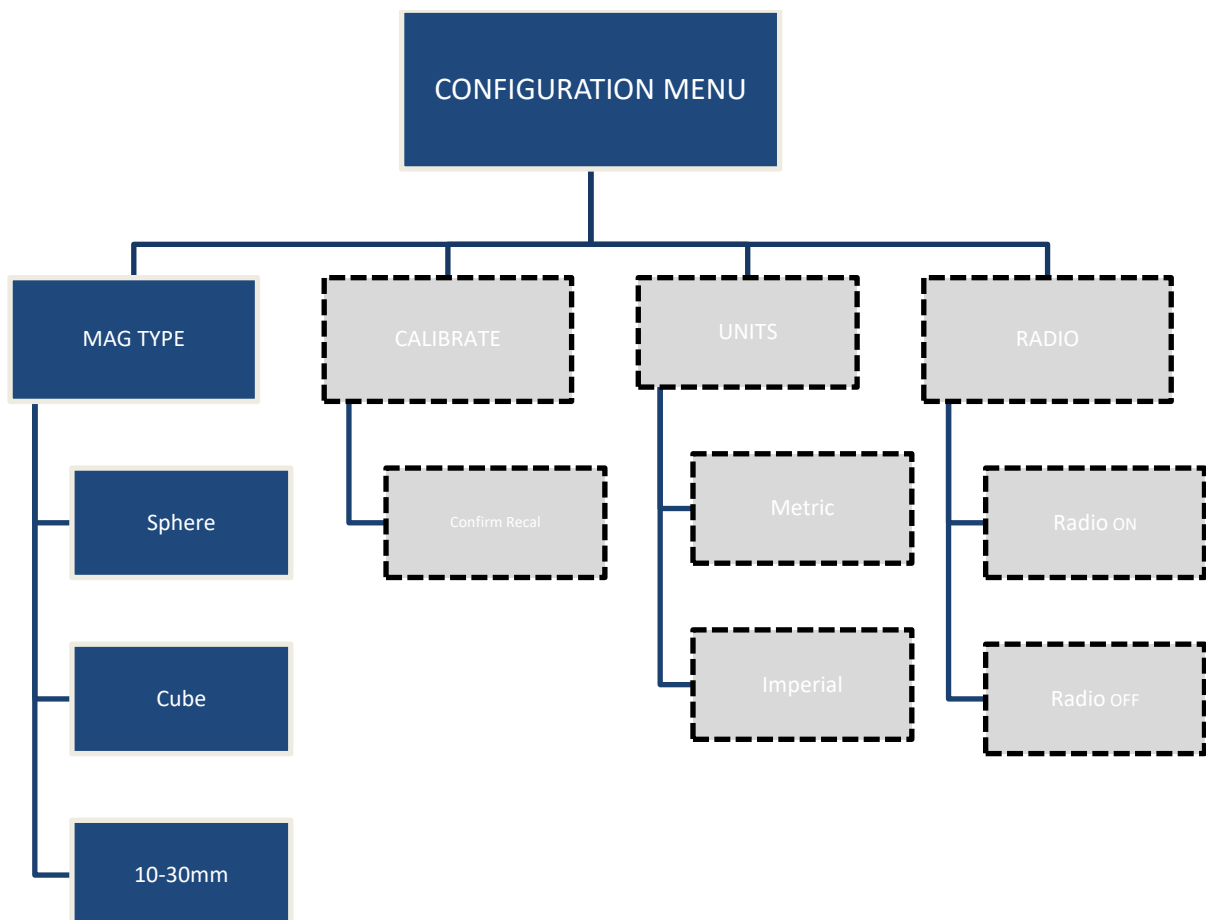

6 POSITIONING OF THE SENSOR HEAD

The correct position and orientation of the sensor head on the part surface is essential to ensure an accurate reading is taken.

6.1 Correct Sensor Head Position & Orientation.

When measuring flat parts ensure that the sensor head is perpendicular to the surface.

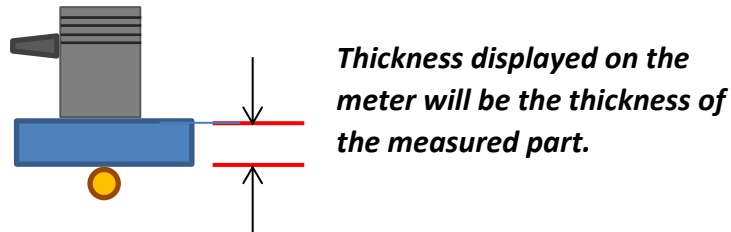

When measuring external radius, it is important to ensure that the sensor head is perpendicular to the surface of the part being measured.

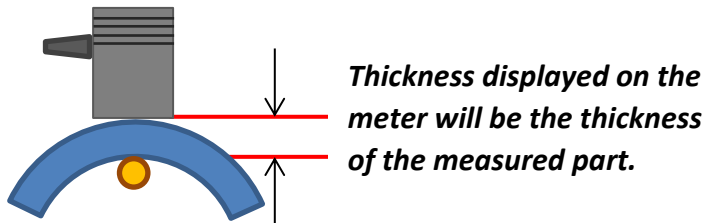

Incorrect Sensor Head Orientation: a non-perpendicular orientation will result in an erroneous measurement.

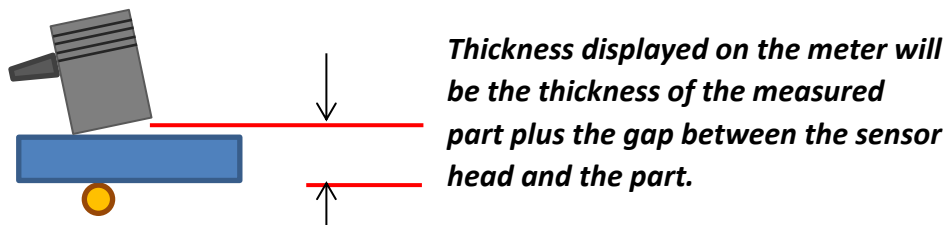

An internal radius will return a value for which compensation must be made.

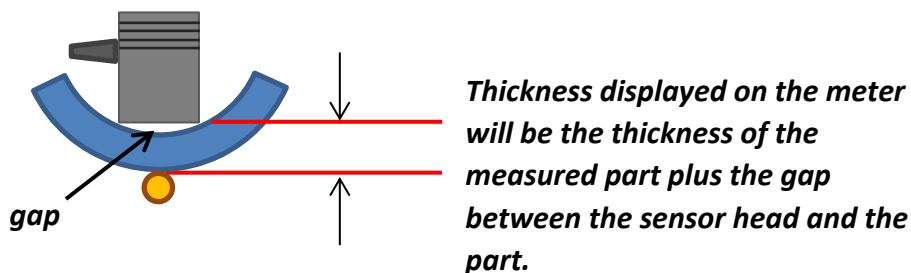

6.2 Measuring an External Radius with K-METRON.

It is straight forward to measure external radii down to 5mm. Place the sensor head on the surface of the part located at external radius to be measured. Ensure that the sensor head is perpendicular to the tangent of the radius to make an accurate reading.

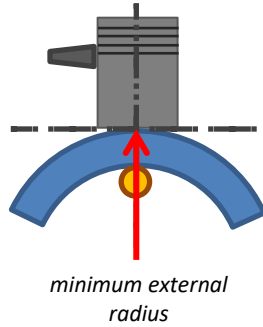

A minimum external radius of 5mm (3/16") can be measured using the supplied 10mm diameter magnetic sphere.

A minimum external radius of 3.3mm (0.1229") can be measured using a 6.6mm diameter magnetic sphere (contact for supply).

6.3 Measuring an Internal Radius with K-METRON.

It is straight forward to measure an external radius down to 5mm. At radii less than this the main difficulty is with access to the surface. When measuring thickness of internal radii, the correct measurement often requires compensation for the gap distance as shown below.

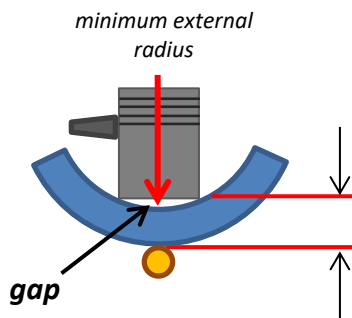

A minimum internal radius of 25mm (1") can be measured before it becomes impractical and difficult to compensate for gap distances. Radii less than 25mm also tend to allow the magnetic force to pull the magnet to the side of the part.

6.4 Sensor Head Care

DO NOT ALLOW THE TRANSDUCER MAGNET TO 'SNAP' TO THE FACE OF THE SENSOR – SEVERE DAMAGE MAY OCCUR TO THE DEVICE SENSOR AND MAGNET.

Keep the Sensor Head and magnet away from computer displays or any product which is sensitive to strong magnetic fields. Permanent damage may occur to such devices.

The Sensor is highly sensitive to magnetic fields and temperature. High temperature environments may also affect the accuracy of readings.

The instrument has been factory calibrated to accuracies shown in the table below.

Regular checks should be made to ensure the instrument is operating within its capabilities and it is recommended that the unit is returned to 493K Limited for an annual recalibration

to ensure its continued performance is maintained. 493K offer a return carriage paid service, calibration, and inspection.

6.5 The Sensor Head Dimensions.

The sensor head is a cylinder of size 28mm diameter x 55mm length.



Diameter of sensor head.



Length of sensor head.

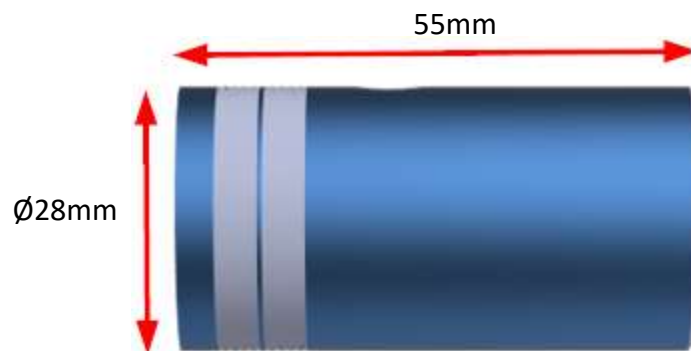

7 TAKING A THICKNESS MEASUREMENT

When the sensor head is at the desired measuring point **pull and hold the orange trigger** and make small **figure of eight** movements of the Sensor Head to ensure the Transducer Magnet is centrally located on the Sensor Head. Centring of the calibrated magnet will easily occur on materials up to 20mm (0.78") thick but will also depend on the surface finish of the material being measured.



On releasing the trigger, the unit will display and transmit the **minimum value** measured to the receiver. The data that are sent to the PC are the Date, Time, Mould Identification Number, the Mould Position Number and the Thickness Reading.

If the receiver is not connected to the PC or the handheld transmitter is out of radio range of the receiver then a 'TX Error' will be displayed on pulling the Orange Trigger. The unit is still operational and can be used to display on-screen readings without the receiver being connected to the PC, however users should be aware that a 'TX Error' indicates that the reading is not saved on the PC. If it is not the intention to use the radio link this facility can be turned off in the Configuration Menu in the "Radio" selection.

7.1 Out of Measurable Range Thicknesses.

During the calibration of a spherical or cube magnet the unit will determine at which maximum thickness the sensor magnets become out of range and then will display O/R for 'out of range' when appropriate. The O/R limit is reached whenever the effect of the magnet on the sensor head is too small to provide a useful measurement. It is also seen when no magnet is present, such as would happen when the magnet becomes de-coupled. For a limit where the thickness decreases to zero and the measurement is out of range, "LOW" will be displayed.

7.2 Deleting a Thickness Measurement.

If an erroneous thickness measurement has been made and transmitted to the PC then it can be remotely deleted from the PC. To do this press the X (or “Delete”) button; the display signals confirmation. The Position Number on the PC will then be reduced by ‘1’.

7.3 Indexing Mould ID.

After the thickness measurements on a particular mould are completed the user has the option to increment the Mould Identification number. This number is used as a guide to indicate which moulds are being measured and recorded.

To increment the Mould Index number, complete the following two steps:

Step 1. Move the magnet away from the sensor head so that O/R (‘out of range’) is displayed on-screen;

Step 2: Hold the trigger down for 7 seconds.

The on-screen indication will now show that the Mould Index number has been incremented.

7.4 Units of Measurement

Measurements can be made using IMPERIAL or METRIC units. Units are changed in the Configuration Menu under the “Units” section. To enter the Configuration Menu:

1. Hold down the X button (or “Delete” button in older models) and switch the unit on by pressing the On/Off button.
2. Continue to hold down the X (or “Delete”) button, the display will read “Wait ... Setup mode”.
3. Continue holding down until the display reads “MAG TYPE” then release the X (or “Delete”) button. (Ensure that the orange trigger is not being mistakenly held down).
4. Once the display reads “MAG TYPE”, the unit is now in the Configuration Menu.

The Configuration Menu is navigated using the following buttons:

To SCROLL through the Menus press X (or “Delete”).

To SELECT a Menu item, press the ORANGE TRIGGER.

Scroll through the menu section and select the “Units”; then scroll through METRIC/IMPERIAL/EXIT and select the desired Units. The unit will now exit the configuration menu and return to operational status ready to measure using the units of measurement chosen.

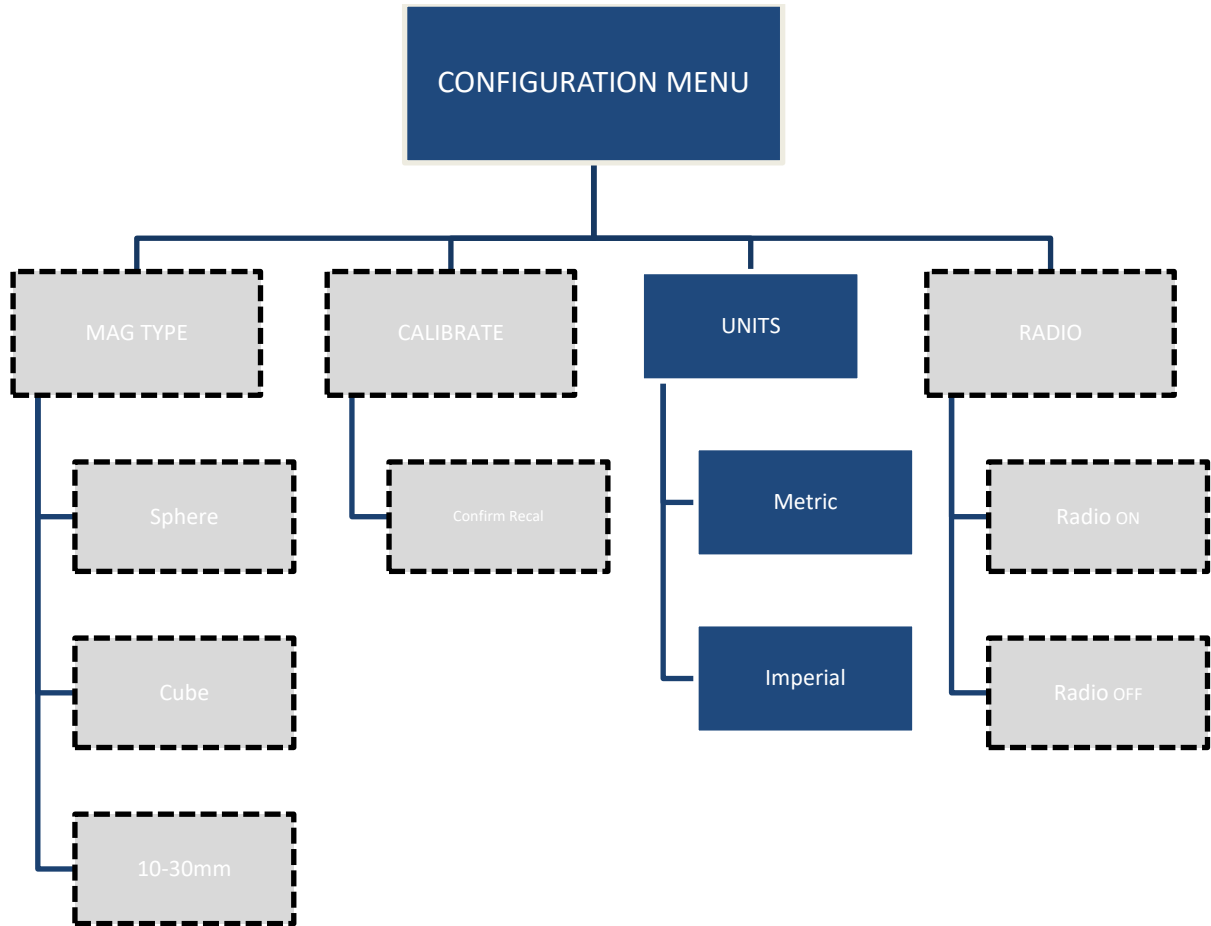

8 USING THE K-METRON'S PC SOFTWARE

8.1 Connecting the K-METRON to the PC & Installing the Communications Driver.

Connect the K-METRON receiver unit to the PC using the attached USB flying lead. Allow Windows to automatically connect to the internet for the latest communication driver. It will do this automatically upon plugging in the USB flying lead.



8.2 Downloading the K-METRON Software.

Download and install the K-METRON software from the link supplied by 493K. If you do not have this link it can be found at www.493k.com under the Software heading.

8.3 Setting the Correct Communications Port.

Ensure that the K-METRON software is set to look at the correct communications port that has been assigned by Windows for the receiver hardware (when the radio receiver was connected and the driver installed, Windows will have auto-assigned this number).

To determine the communication port number that Windows has assigned go to:

- Windows Control Panel
- Device Manager
- Under Ports (COM & LPT) the USB Serial Port will show the COM number that has been allocated by Windows e.g.

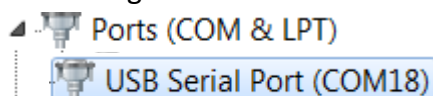

(in this case Windows has assigned the COM number 18)

To assign the COM number withing the K-METRON software:

- Run K-METRON Software
- Go to options and assign the correct COM Port.

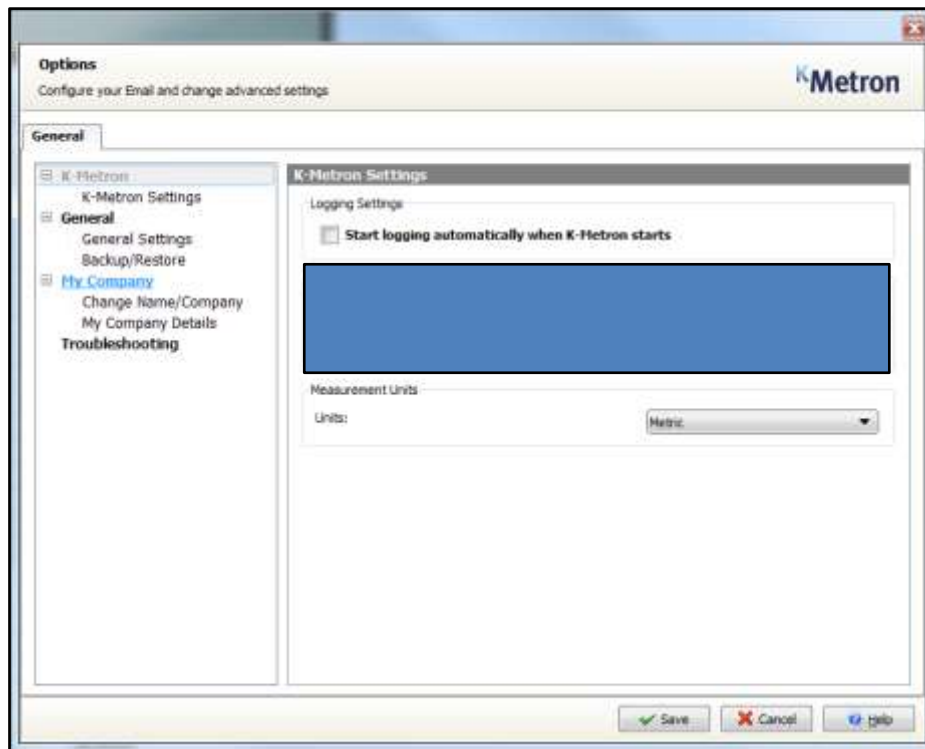

8.4 Start Recording

Click on the Start button within the K-METRON software. Provided the COM port is set up correctly and the receiver is communicating with the PC the Status will be shown as **Waiting for data...**

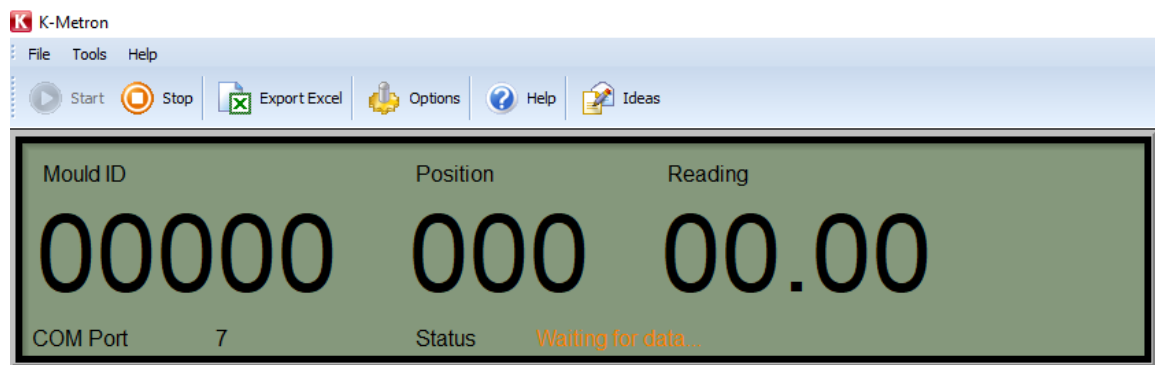

Once the transmission between the handheld unit and the receiver is sent by pulling the orange trigger the Status will change to **Recording...** and the Position number should increment to "001" and the reading displayed as measured. If the Status remains as **Waiting for data...**, even after the orange trigger has been pulled then check that the transmitter and receiver are within radio range and also ensure that the transmitter radio is operational, (i.e. not turned off in the Configuration Menu).

When the K-METRON is not recording the Status is displayed as Stopped.

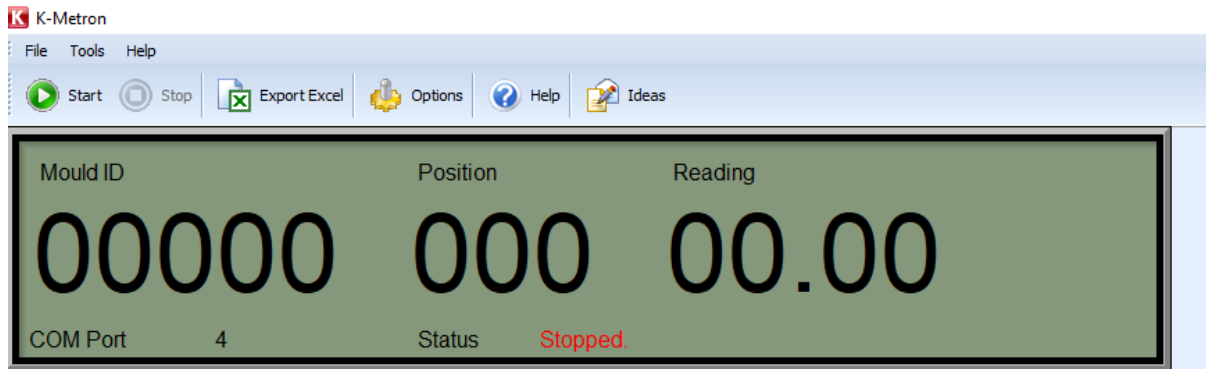

If when the Start button is clicked a warning appears to say “Cannot connect to K-Products” then check to ensure that the receiver is connected and that the correct COM port is selected.

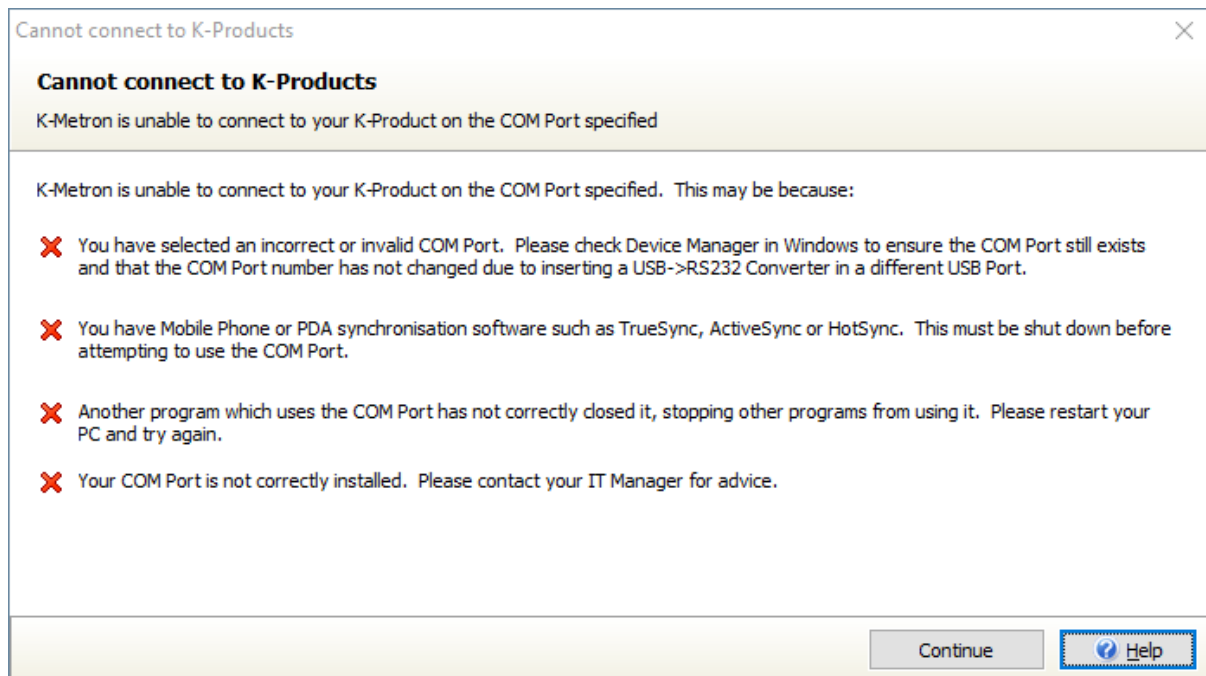

8.5 Activating and De-activating the Radio Communication.

The K-METRON Handheld Radio Module can be activated or de-activated. This is set within the Configuration menu under the section “Radio”. The battery life will be improved when the radio is de-activated and the unit will not show a Tx Error on pulling the orange trigger when the receiver is not connected.

8.6 Recording the Thickness Measurements.

Hit the start button to begin receiving and recording data transmitted from the handheld K-METRON. Received data will be presented on a line per line basis and will record Date, Time, Mould ID, Position number and Reading.

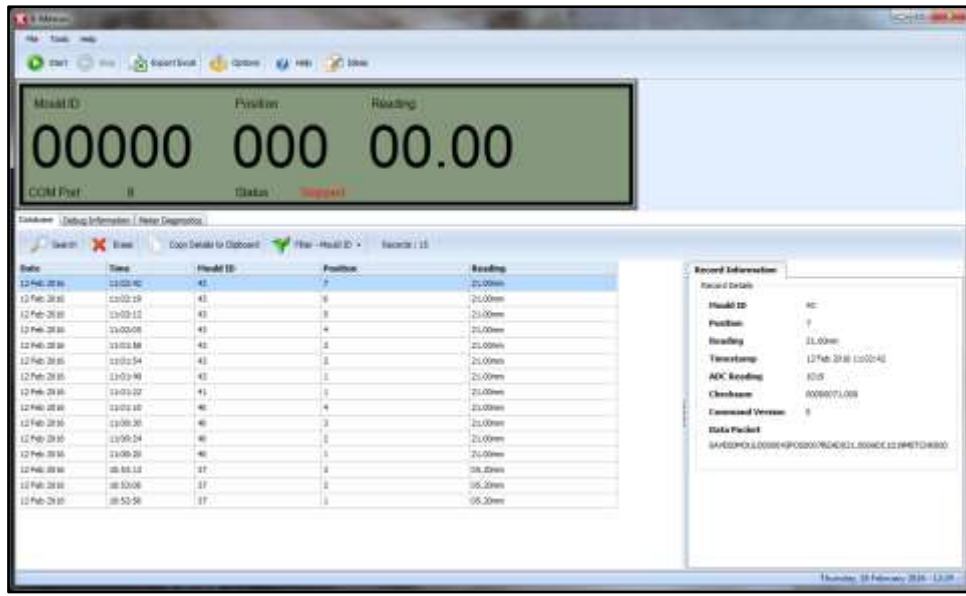

8.7 Continuous Internal Database Recording

The thickness data are stored in the K-METRON’s core database. Unless deleted, all thickness measurements, even over several days, are saved in a single database. This data can be viewed in the database tab in data and time order. A further feature to filter the Mould ID is available to allow the user to select only the values of a particular mould.

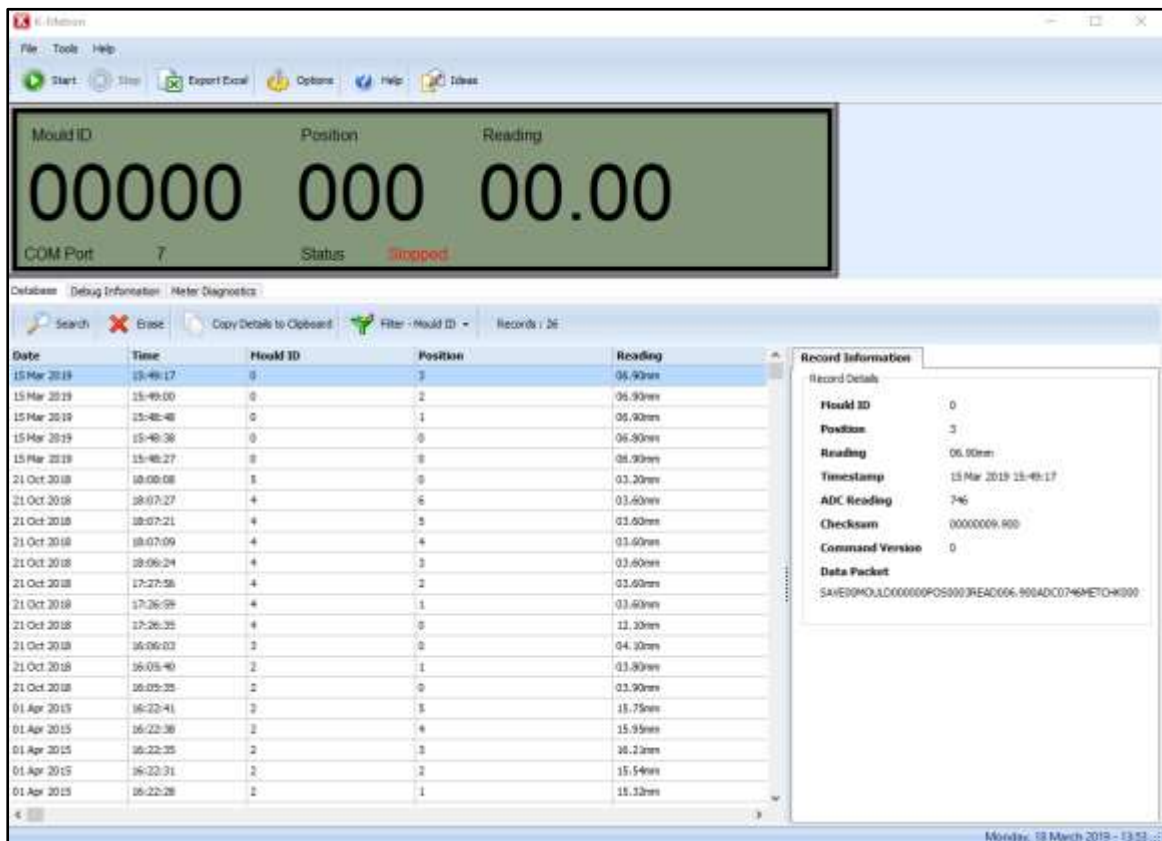

8.8 Exporting to Excel

For more advanced analysis or for report writing the data can be exported to Excel by clicking on the “Export Excel” button at the top of the screen:

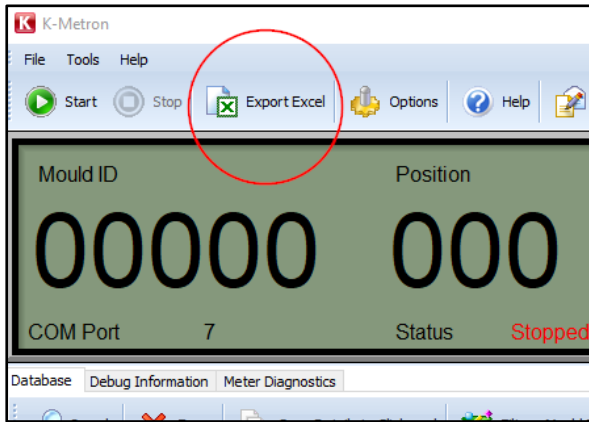

The entire database will be saved out to an Excel file in the following column format:

<Date>, <Time>, <Mould ID>, <Position>, <Reading>

Example:

	A	B	C	D	E
1	Date	Time	Mould ID	Position	Reading
2	15 Mar 2019	15:49:17		0	3 06.90mm
3	15 Mar 2019	15:49:00		0	2 06.90mm
4	15 Mar 2019	15:48:48		0	1 06.90mm
5	15 Mar 2019	15:48:38		0	0 06.80mm
6	15 Mar 2019	15:48:27		0	0 06.90mm
7	21 Oct 2018	18:08:08		5	0 03.20mm
8	21 Oct 2018	18:07:27		4	6 03.60mm
9	21 Oct 2018	18:07:21		4	5 03.60mm
10	21 Oct 2018	18:07:09		4	4 03.60mm
11	21 Oct 2018	18:06:24		4	3 03.60mm
12	21 Oct 2018	17:27:56		4	2 03.60mm
13	21 Oct 2018	17:26:59		4	1 03.60mm
14	21 Oct 2018	17:26:35		4	0 12.10mm
15	21 Oct 2018	16:06:03		3	0 04.10mm
16	21 Oct 2018	16:05:40		2	1 03.80mm
17	21 Oct 2018	16:05:35		2	0 03.90mm
18	01 Apr 2015	16:22:41		2	5 15.75mm
19	01 Apr 2015	16:22:38		2	4 15.95mm
20	01 Apr 2015	16:22:35		2	3 16.21mm
21	01 Apr 2015	16:22:31		2	2 15.54mm
22	01 Apr 2015	16:22:28		2	1 15.32mm
23	01 Apr 2015	16:22:04		1	5 15.75mm
24	01 Apr 2015	16:21:39		1	4 15.95mm
25	01 Apr 2015	16:21:21		1	3 16.21mm
26	01 Apr 2015	16:20:52		1	2 15.54mm
27	01 Apr 2015	16:20:19		1	1 15.32mm
28					
29					

Since the user may not want the entire database to be exported to Excel it may be preferable to delete all data from the database after they have been exported and saved in Excel, thus leaving a clear database for next use.

The data can also be copied & pasted into other programs using the “Copy Details to Clipboard” button and then by pasting accordingly. To paste into Excel, use the Text Import

Wizard and the Comma delimited import setting. Only the data that have been selected and copied will be exported in this case and not the entire database.

8.9 Erasing Unwanted Data.

To erase a single line of unwanted data first select that line with the mouse or by scrolling up and down with the arrow keys, and then clicking on the “Erase” button.

To erase a block of unwanted data select the first line and then while holding down the shift key select the last line of the data (using either the mouse or the arrow keys). Then click on the Erase button to delete the entire block of data.

9 K-METRON BATTERY POWER

9.1 Battery Type

K-METRON is designed for use with a single Lithium PP3 9-volt battery. Using a non-lithium variant of a PP3 9-volt battery, such as an alkaline battery, will significantly reduce battery life. An equivalent rechargeable battery may also be used but this will require regular removal of the battery to charge it separately.

9.2 Replacing the Battery in K-METRON

To replace the battery, remove the cover screw. Carefully unclip the spent battery from the battery cover lid and unclip the battery terminals from the flying power lead. Attach the terminals on the new battery and ensure they clip on securely. Insert the charged battery into the clip and remount the cover. Make sure the battery cable is not trapped by the cover.



9.3 Battery Life

It is recommended that a PP3 lithium battery is used to provide the longest battery life. When used continually without transmitting data the battery life is in the region of 50 hours based on transmission of data at a rate of 10 transmissions/hour the estimated battery life would be in the region of 40 hours. NB. If a Lithium battery is not used the battery life may be significantly compromised.

10 K-METRON - WHAT'S INCLUDED

The system comprises:

1. A portable display unit containing the measurement electronics;
2. A Lithium PP3 9volt battery;
3. Sensor Head with lead attached to the display unit;
4. 2 x spherical 10mm magnets;
5. 1 x 10mm cube magnet with retrieval cord;
6. Magnetic telescopic pick up tool;
7. 1mm - 20mm Calibration Steps;
8. Instruction Manual (downloaded via link supplied);
9. K-METRON Software (downloaded via link supplied);
10. 493K carry bag.

11 TECHNICAL SPECIFICATIONS

Range:	2 to 20mm (magnet dependent)
Resolution:	0.1mm
Accuracy:	+/- 0.2mm or +/- 1mm depending on magnet used and range
Range error:	Better than +/- 0.3mm
Temperature:	5°C to 35°C (41°F to 95°F)
Calibration:	@ 20°C (68°F)
Minimum radius measured:	(10mm Cube): 20mm (10mm Spherical): 5mm
Power Supply:	1 x Lithium PP3 9volt battery (recommended) 1 x Alkaline PP3 9volt battery (although the K-METRON will work with Alkaline batteries there will be a significantly reduced battery life)

12 DISCLAIMER

Use of this instrument is at the operators' risk and 493K Limited will not be held liable for any claims for damage to other equipment occasioned by its use or any consequential claims related to the instrument's accuracy.

13 DECLARATION OF CONFORMITY

We the manufacturer 493K Limited
 23 Watch Hill Road
 Ballyclare
 Co. Antrim
 BT39 9QW
 United Kingdom

declare under our sole responsibility that the product :-

K-METRON, Model No. 2.0

to which this declaration relates is in conformity with the following standard(s) or other normative document(s) :-

EN55022 : 1988 Class B
EN50082-1
IEC 801-2 : 1991
IEC 801-3 : 1984
IEC 801-4 : 1988

following the provisions of :-

EC EMC 2004/108/EC.

Place of issue 493K Limited
 23 Watch Hill Road
 Ballyclare
 Co. Antrim
 BT39 9QW
 United Kingdom

Date of issue **30 Nov 2016**

Signature 

Name **Dr Gareth W. G. McDowell**
Position **Managing Director**